

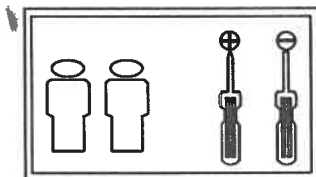









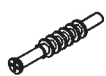





Inhalt - Contents - Contenu - Inhoud - contenuto -contenido-conteúdo - περιεχόμενο

Morris Oak 06 249

Schrank 3 Türen

Beschlagbeutel:



A  16 x	B  15 ohne Rand 20 x	C  3 x 16 11 x	D  SW 4 1 x
E  7 x 40 großer Kopf 5 x	F  10 x	G  2 x	H  16 x
I  H7 9 x	J door left/right Invo Kröpfung 0  9 x	K  3,5 x 15 18 x	L  BA 96 mm 3 x
M  M 4 x 20 6 x	N  1 x Kippschutz	O  2 x	P  mit Gewinde M4 4 x

Den Schrank zum Transportieren anheben. Bitte nicht schieben

Lift the cabinet to move it. Please don't push
 Til de kast op voor transport. Duw alsjeblieft niet

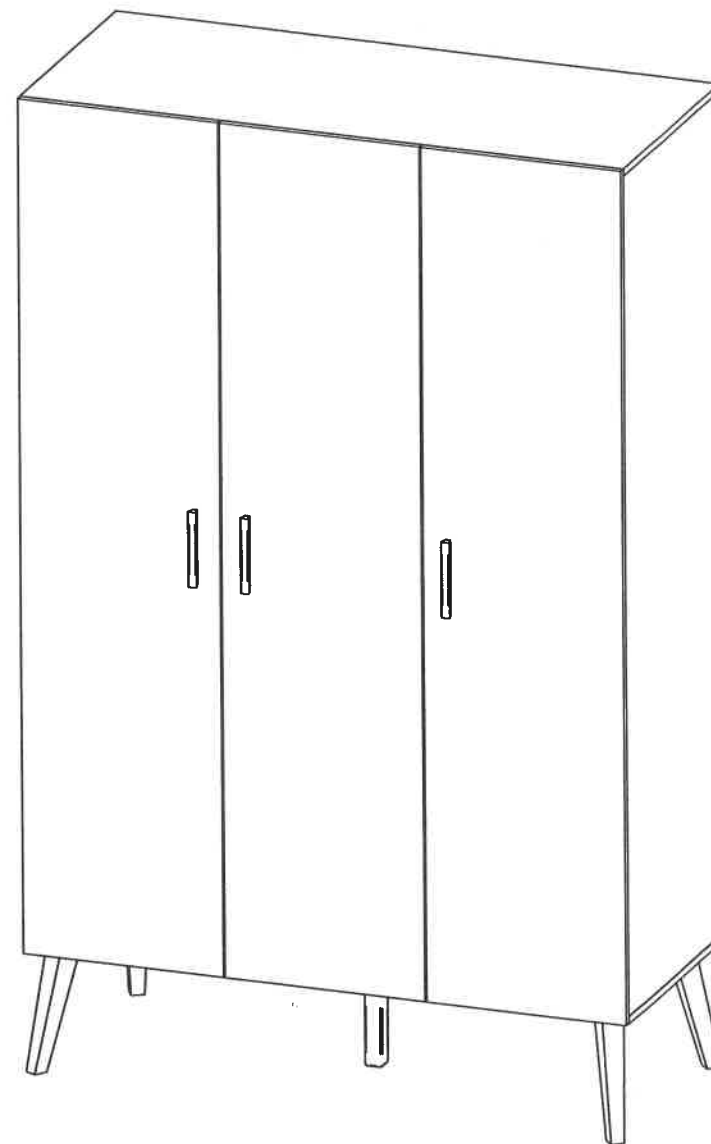

Inhalt - Contents - Contenu - Inhoud - contenuto - contenido - conteúdo - περιεχόμενο

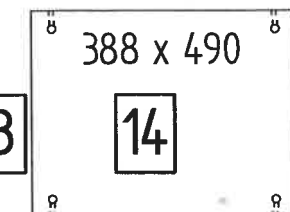
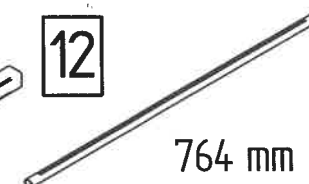
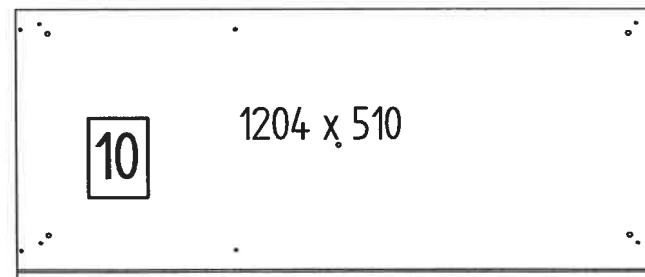
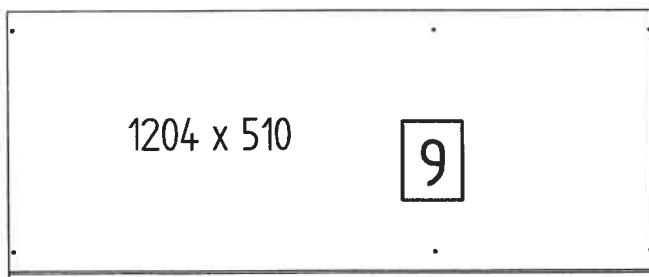
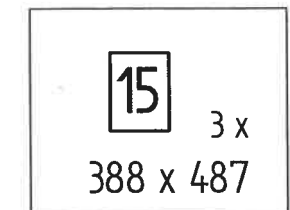
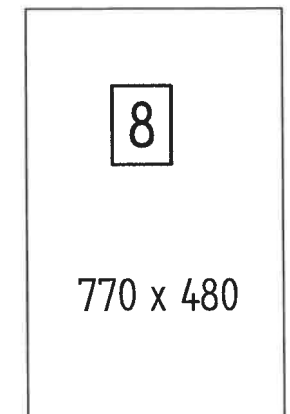
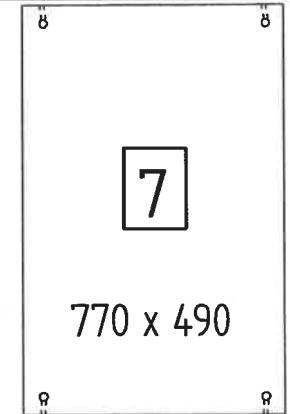
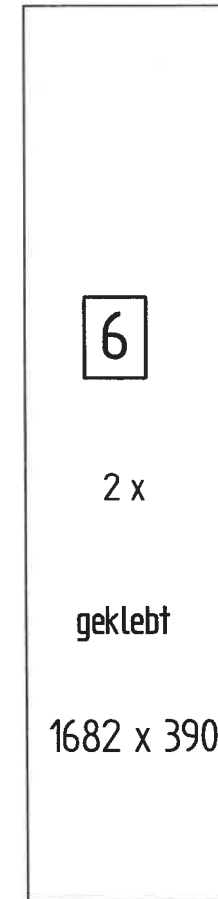
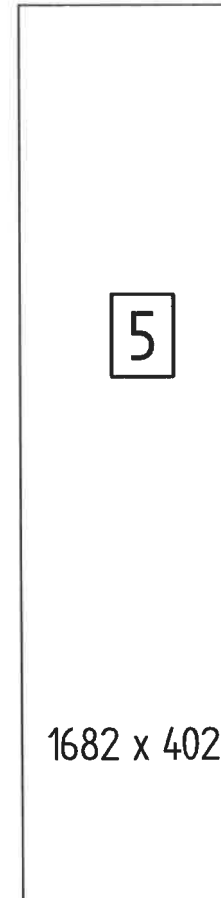
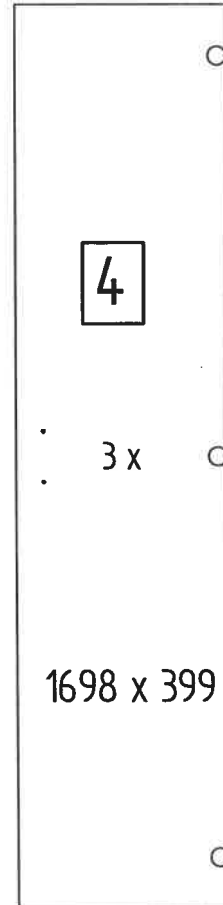
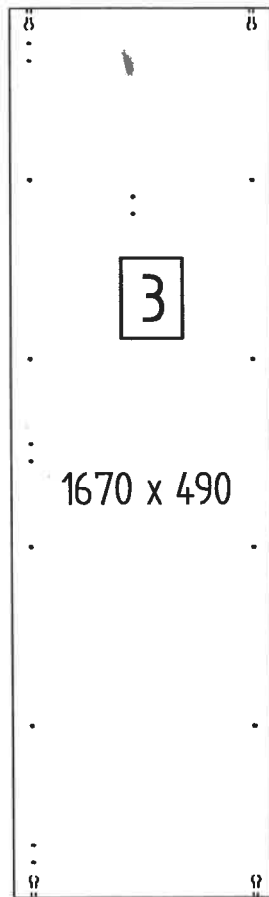
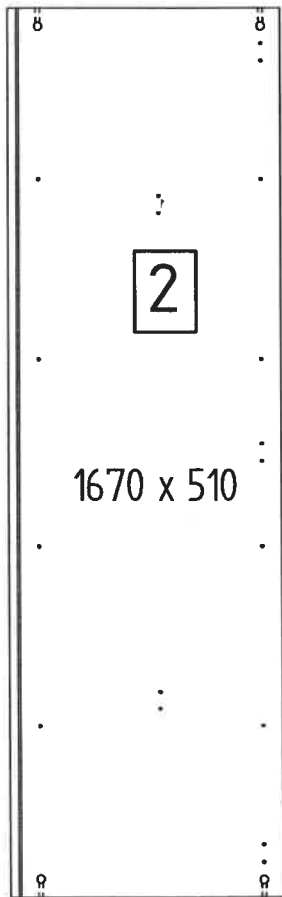
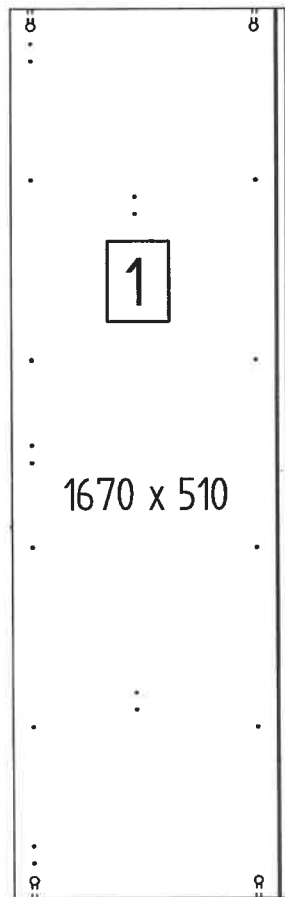

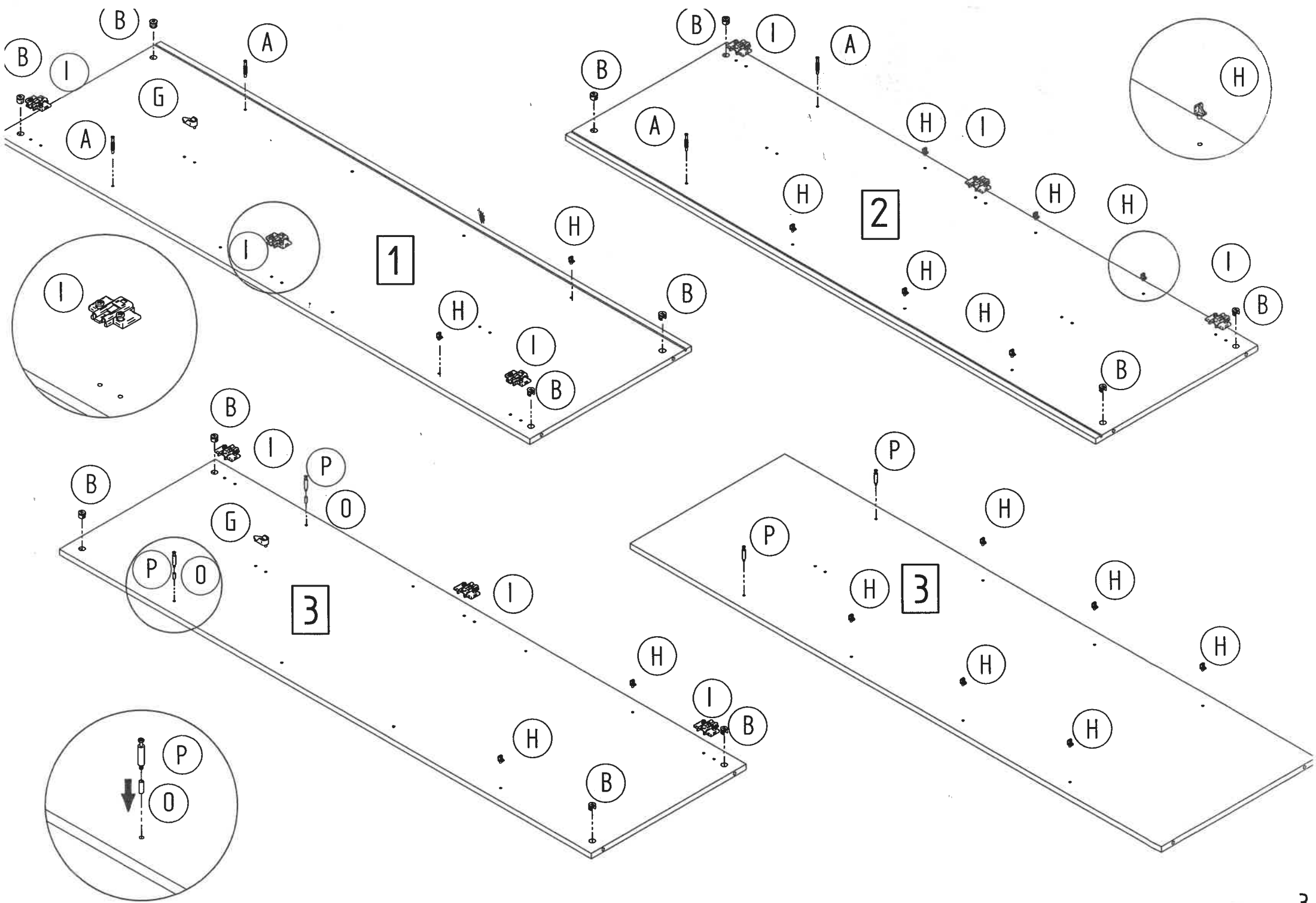

Unterboden mit Nut hinten

Bitte die Füße entsprechend
der Schablone ausrichten und mit den
Schrauben **E** verschrauben

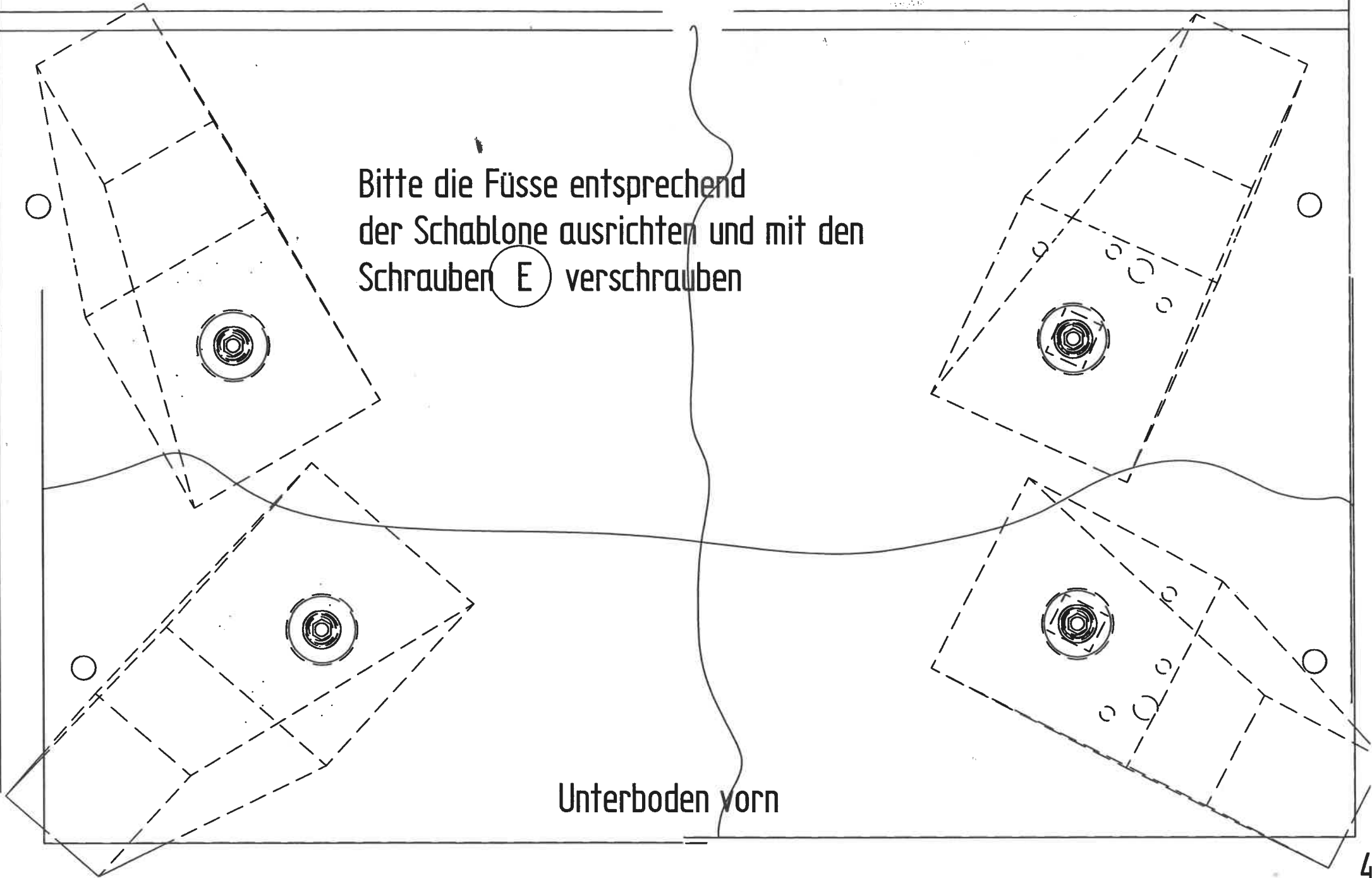

Unterboden vorn

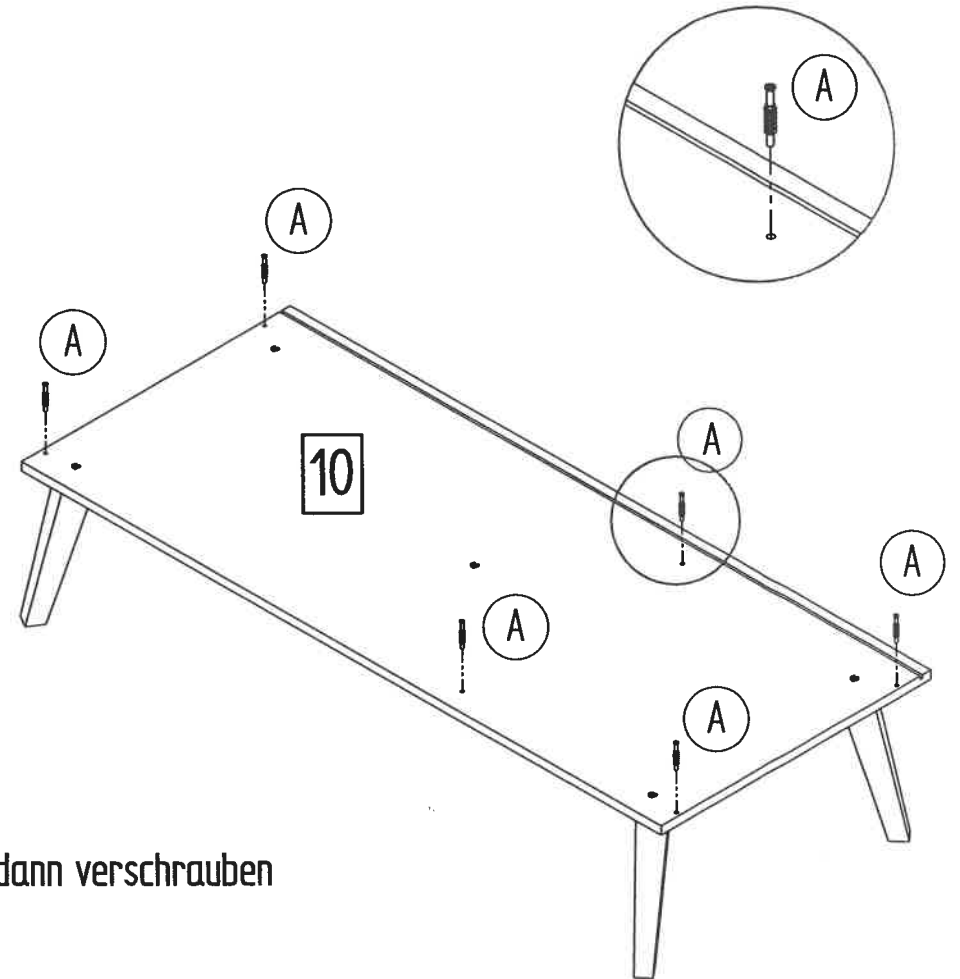
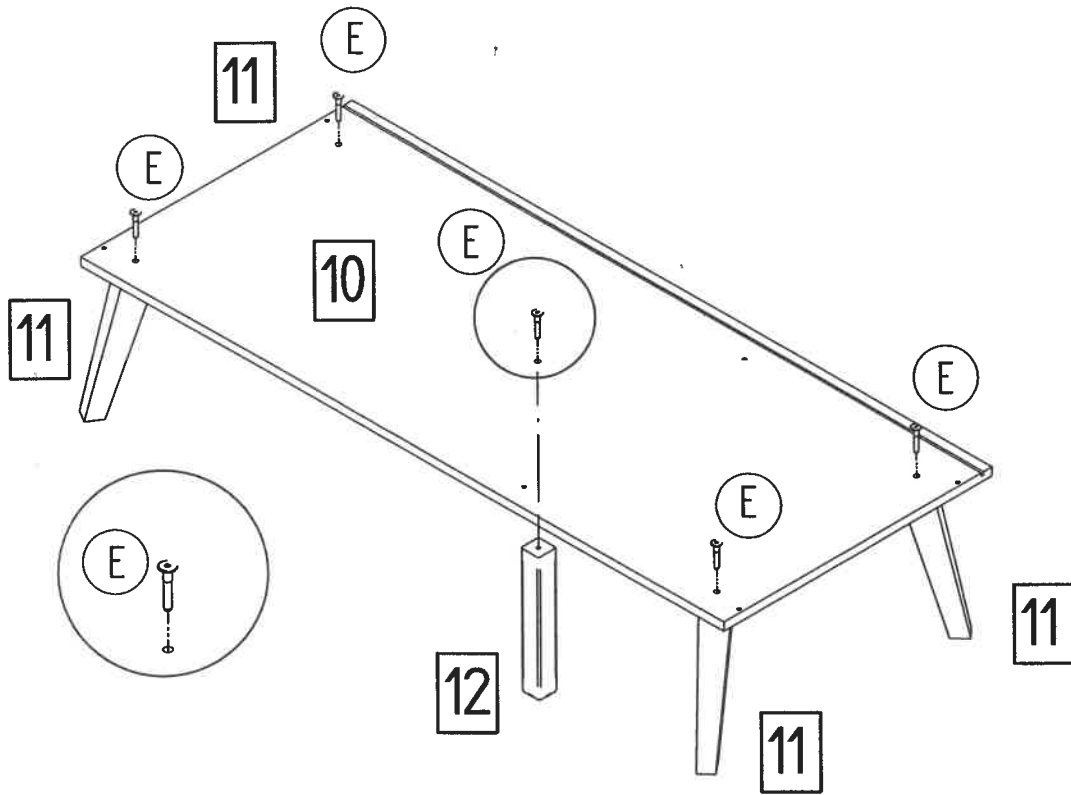
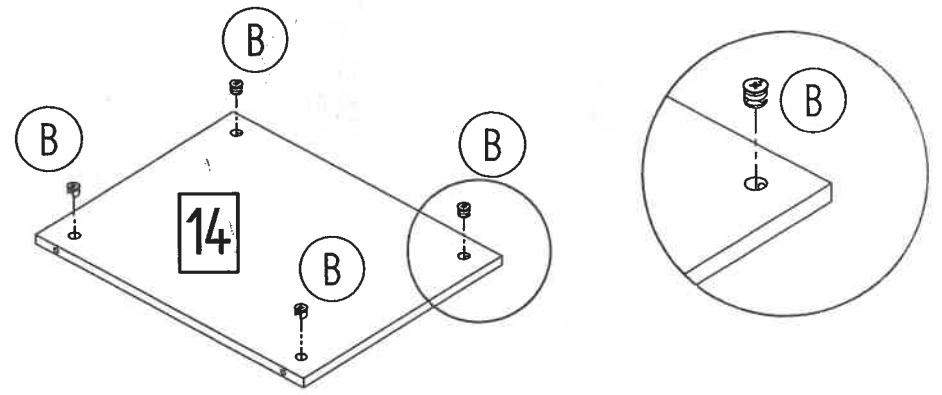
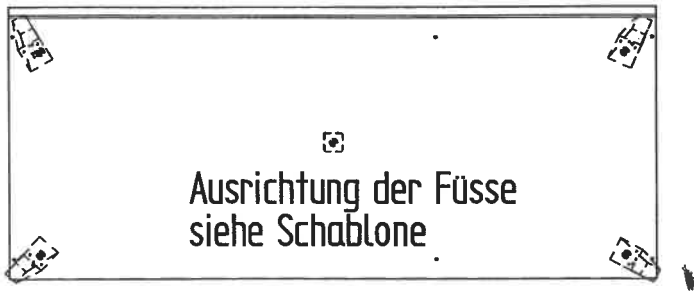

Füße entsprechend der Schablone ausrichten Fuss Mitte ist gerade und dann verschrauben

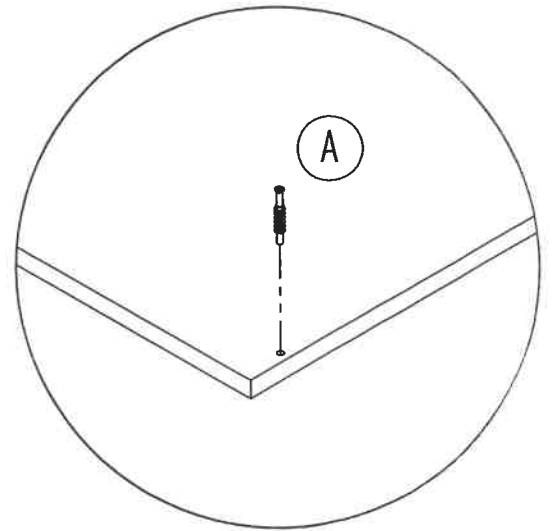
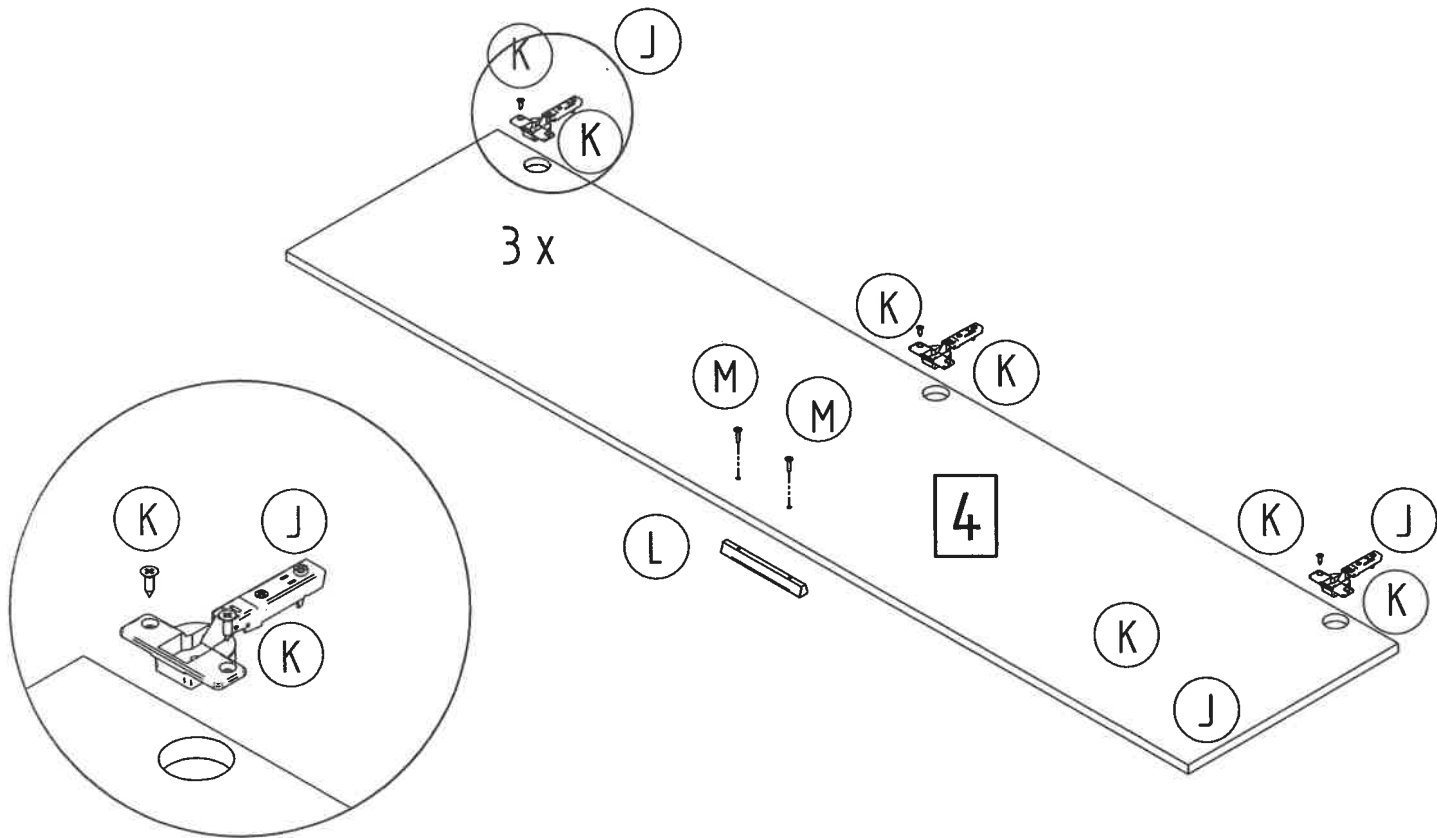
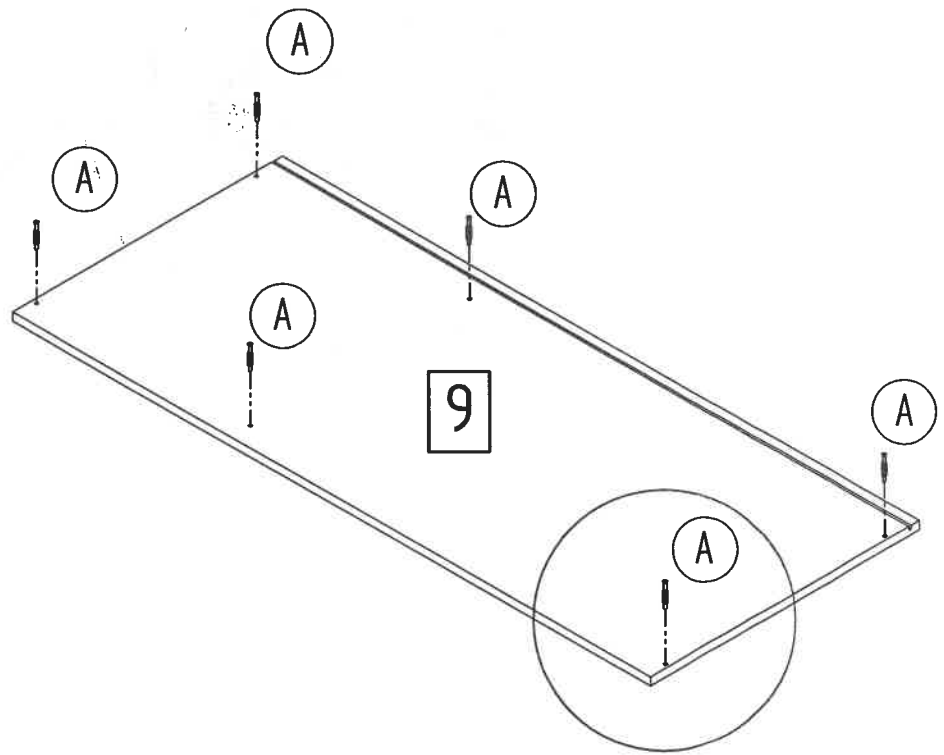
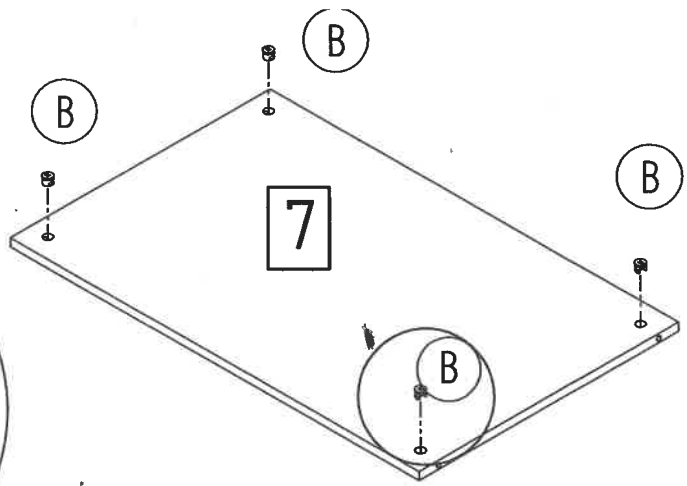
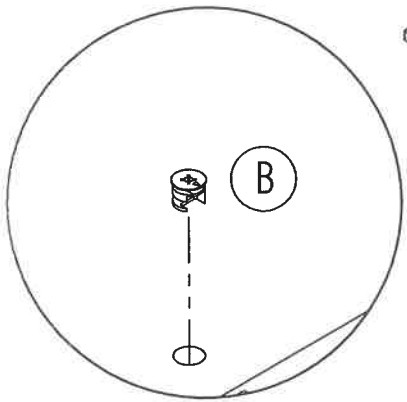

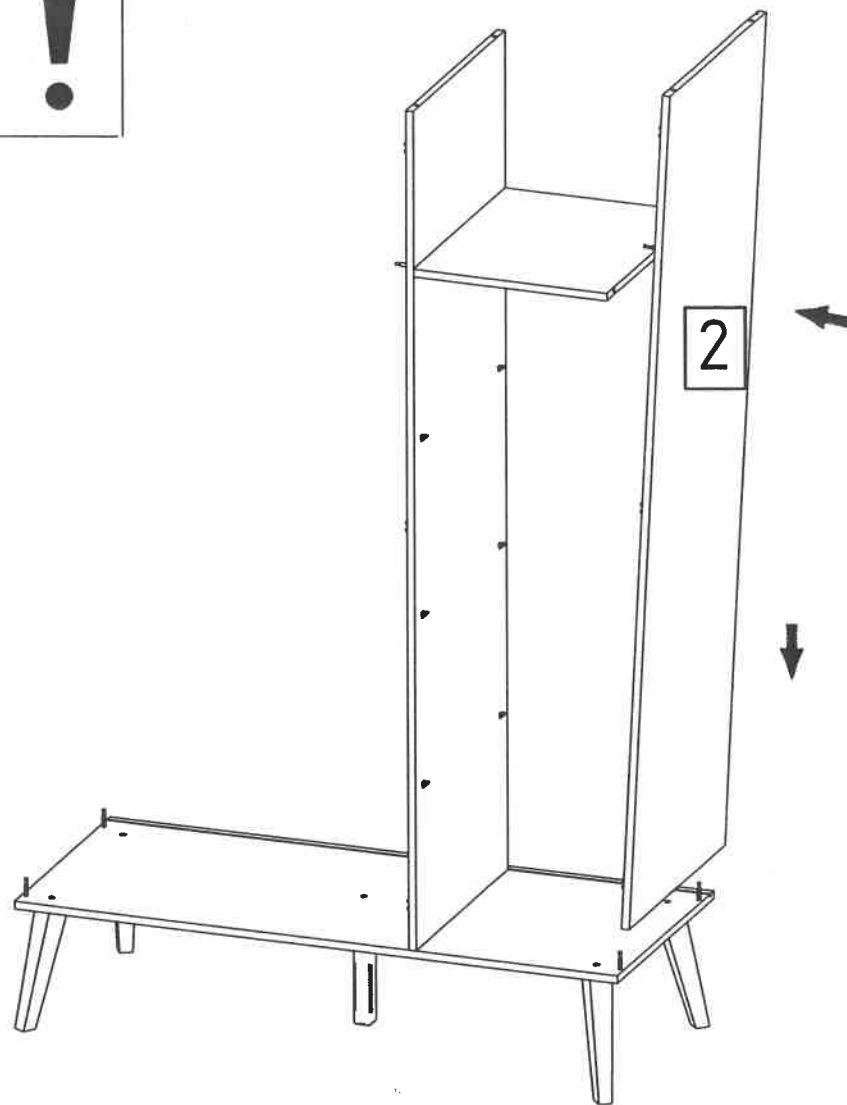
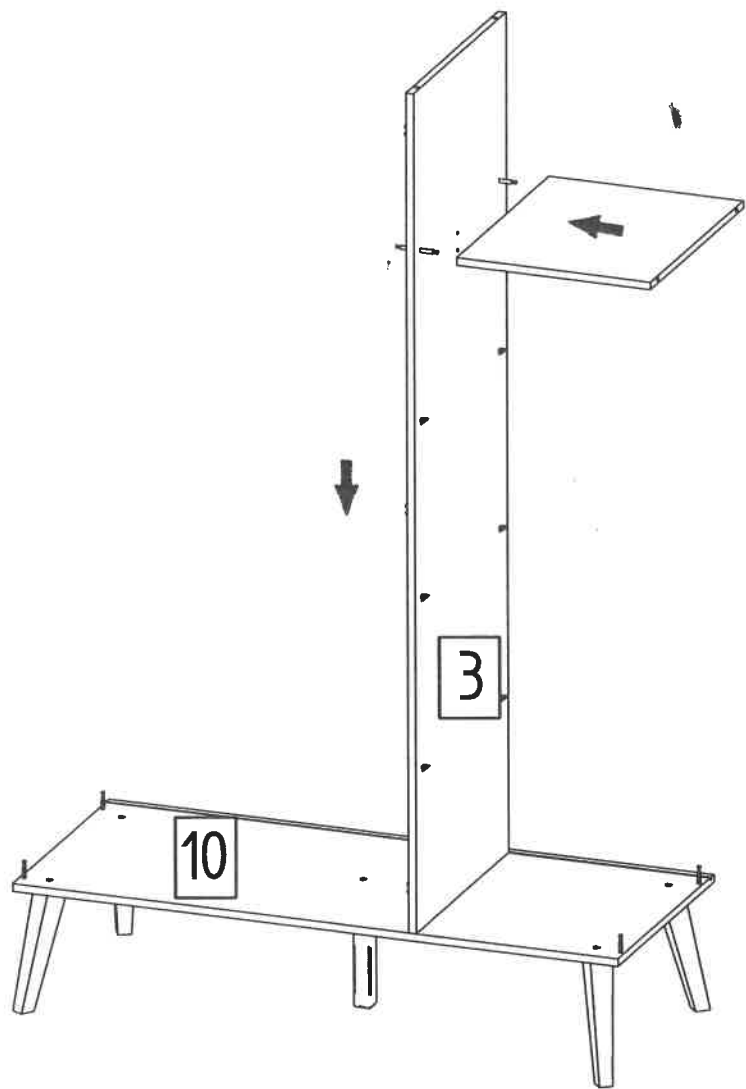
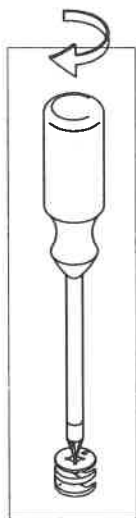
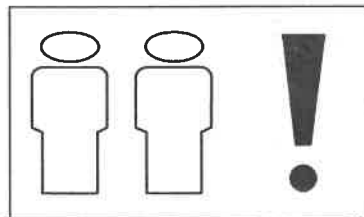

Zusammenbau:

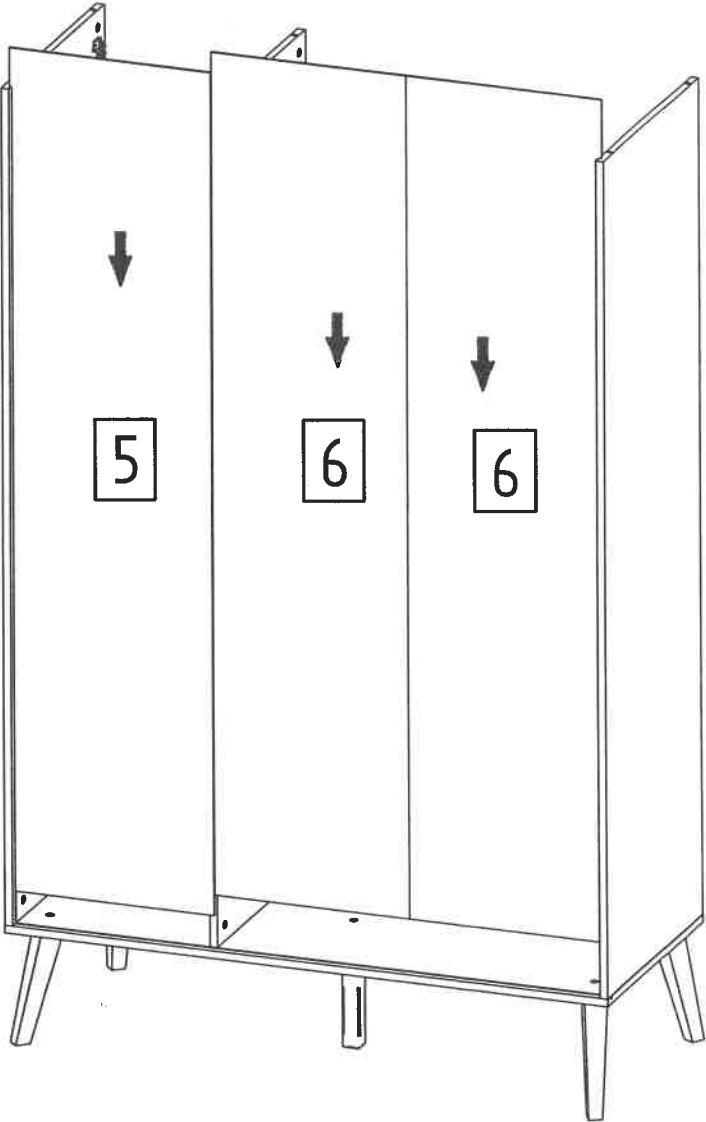
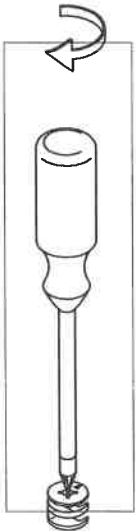
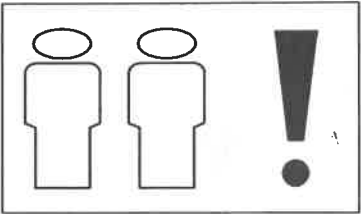
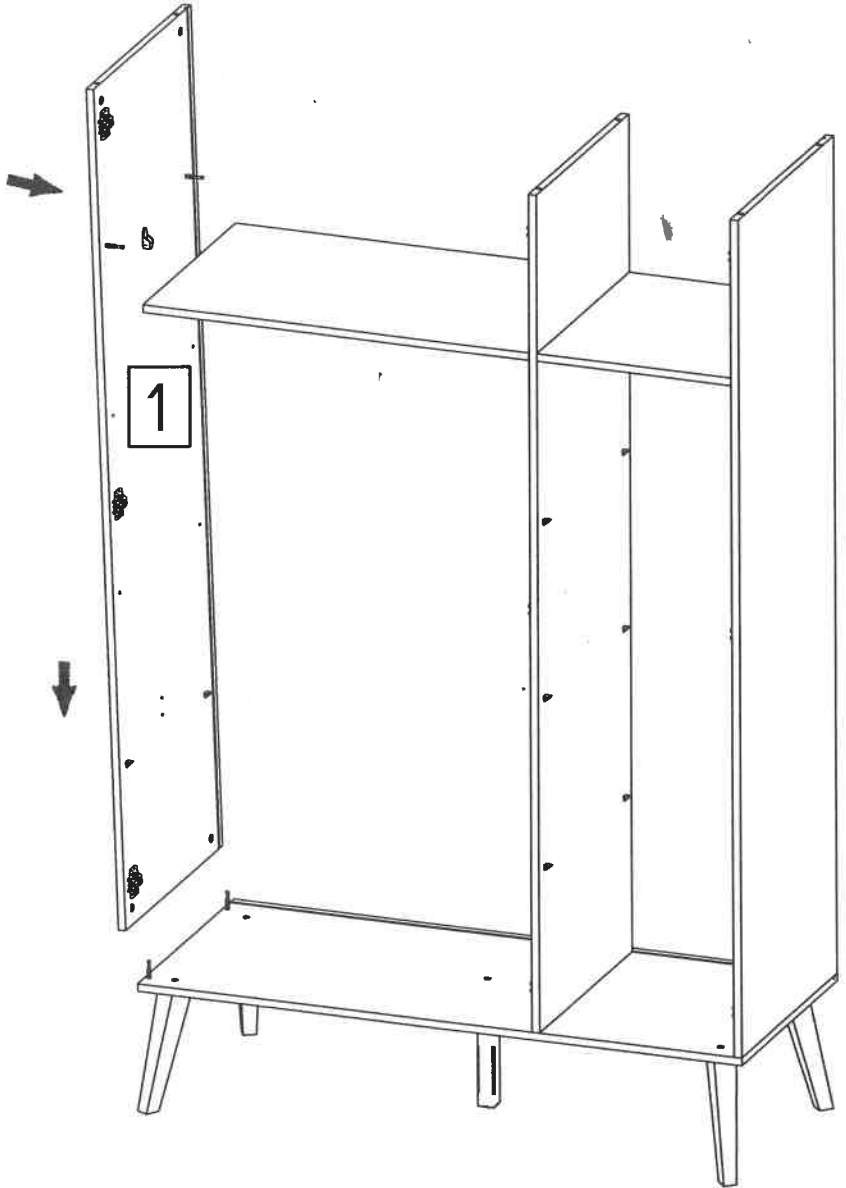

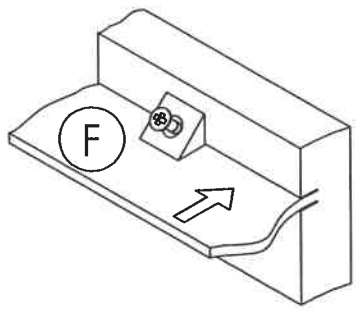
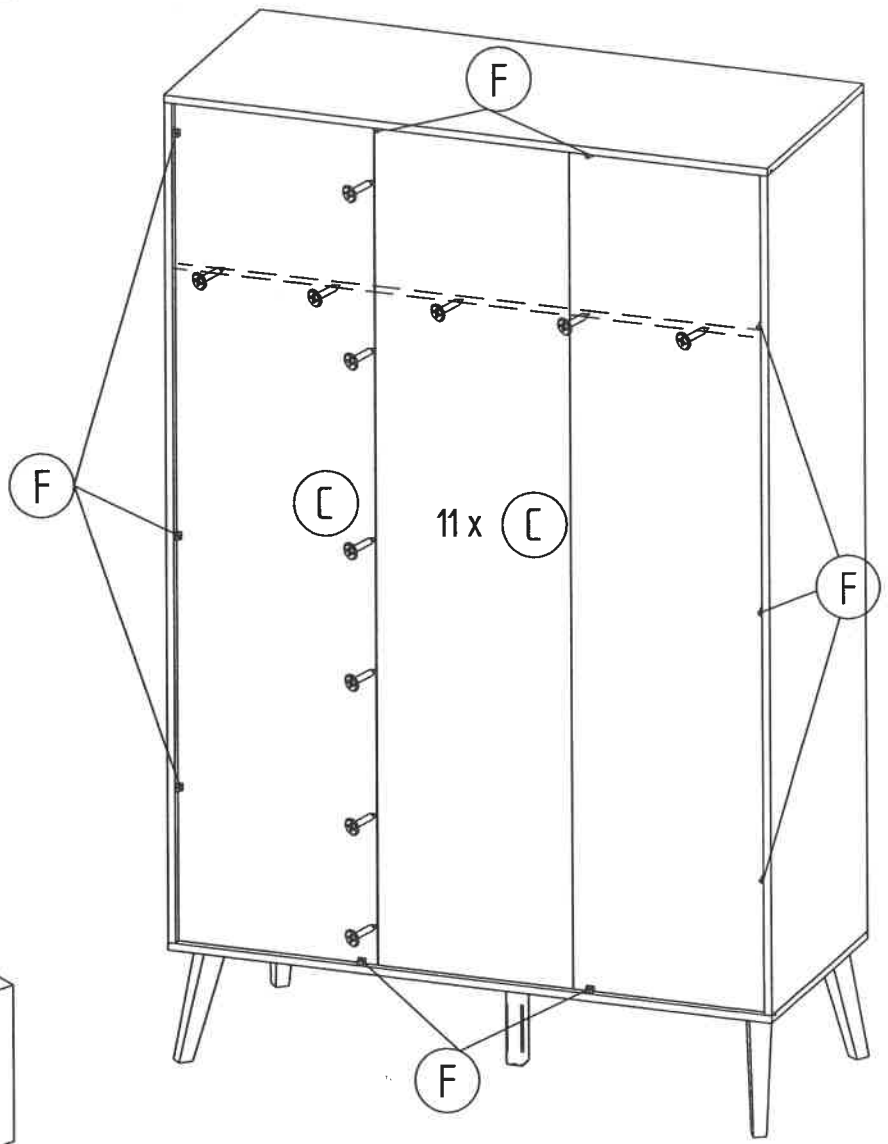
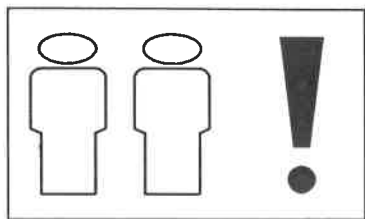
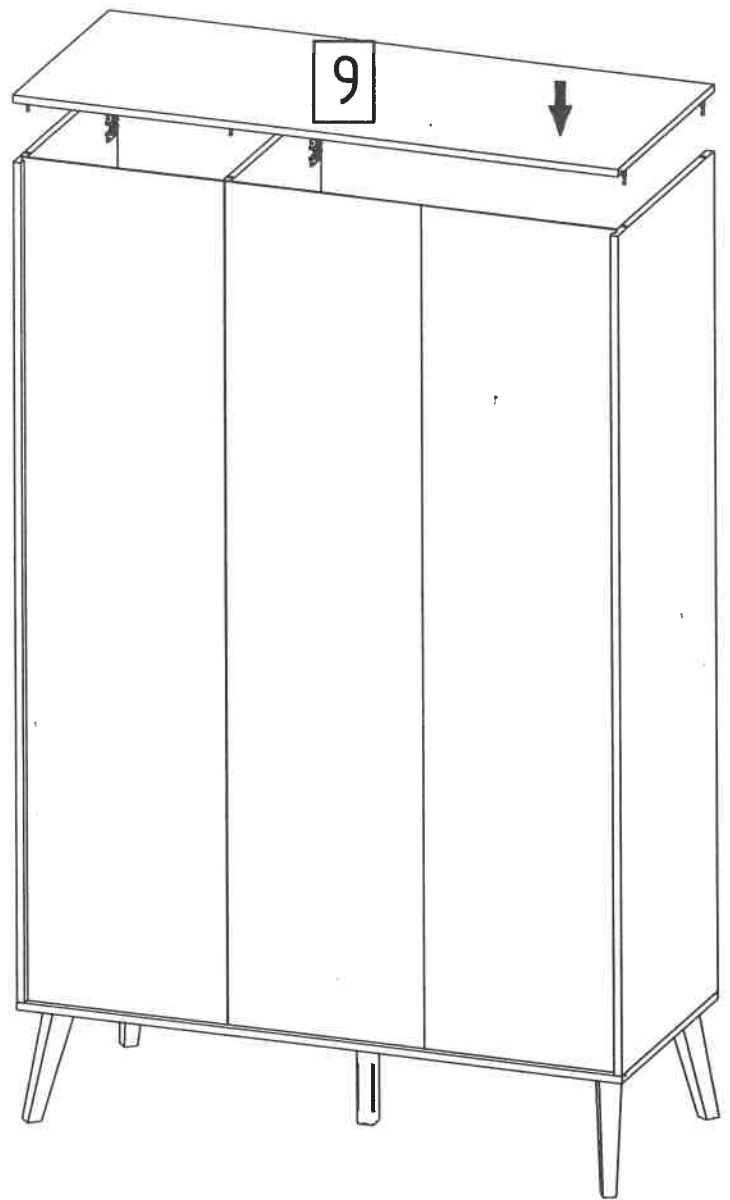

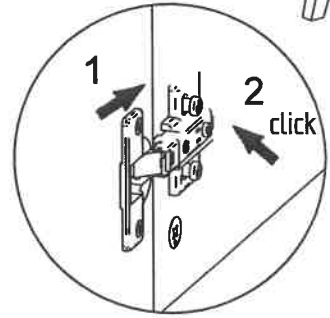
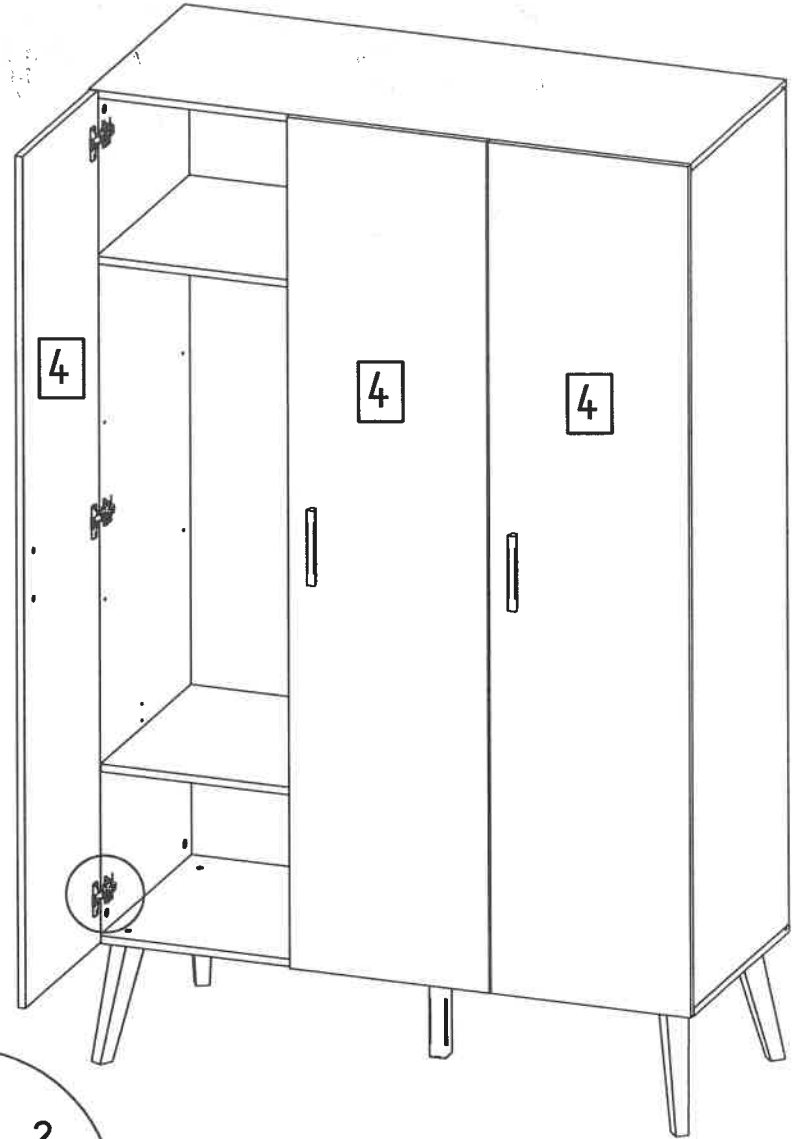
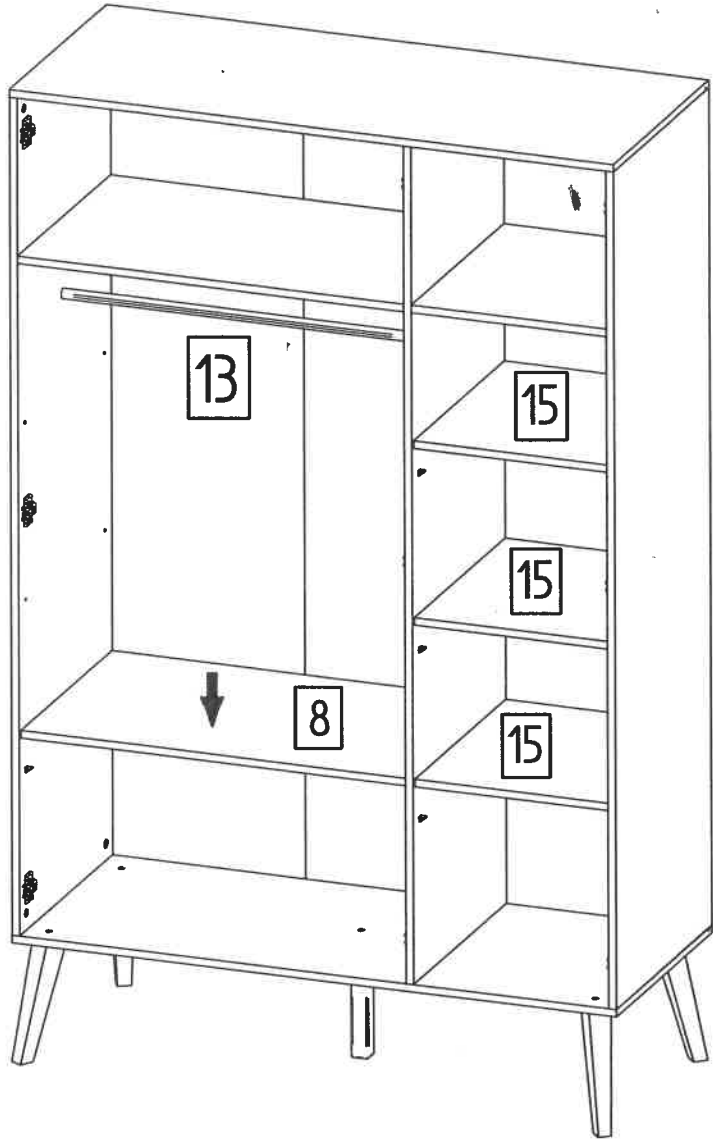

... weitere Infos über unsere Produkte unter

www.schardt.com

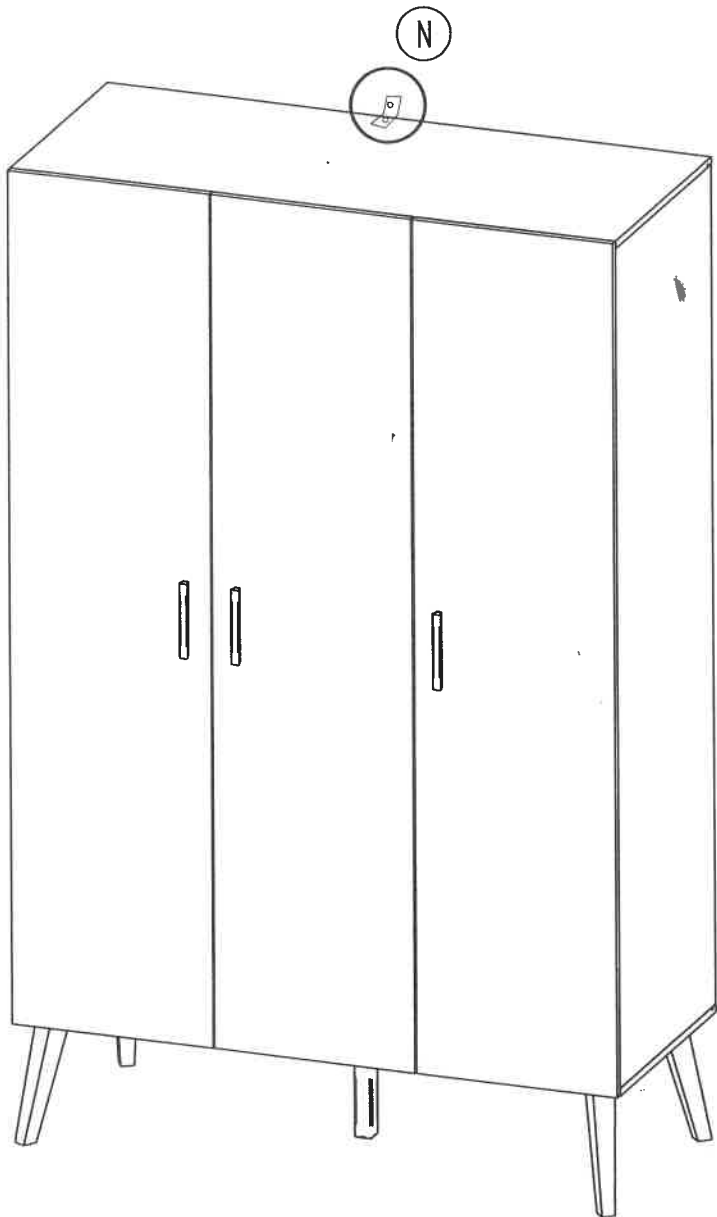

Wandbefestigung:

Den Schrank an der Wand befestigen.

Dazu Kippschutz (N) entsprechend beiliegender Anleitung anschrauben. Anschliessend Kippschutz an der Wand befestigen. Für die Wand geeignete Dübel verwenden. Vor dem Bohren den Verlauf von Strom- und Wasserleitungen unbedingt überprüfen und berücksichtigen!

Den Schrank zum Transportieren anheben. Bitte nicht schieben

Lift the cabinet to move it. Please don't push
Til de kast op voor transport. Duw alsjebliedt niet



Schardt GmbH & Co. KG
Am Riegel 15
96268 Mitwitz
Tel. 09266/9907-0
Fax 09266/9907-77
E-Mail: info@schardt.com